

Silicone Omega Seal Profile 4.5mm x 11.2mm

Product Code: RCOS4.5X11.2S

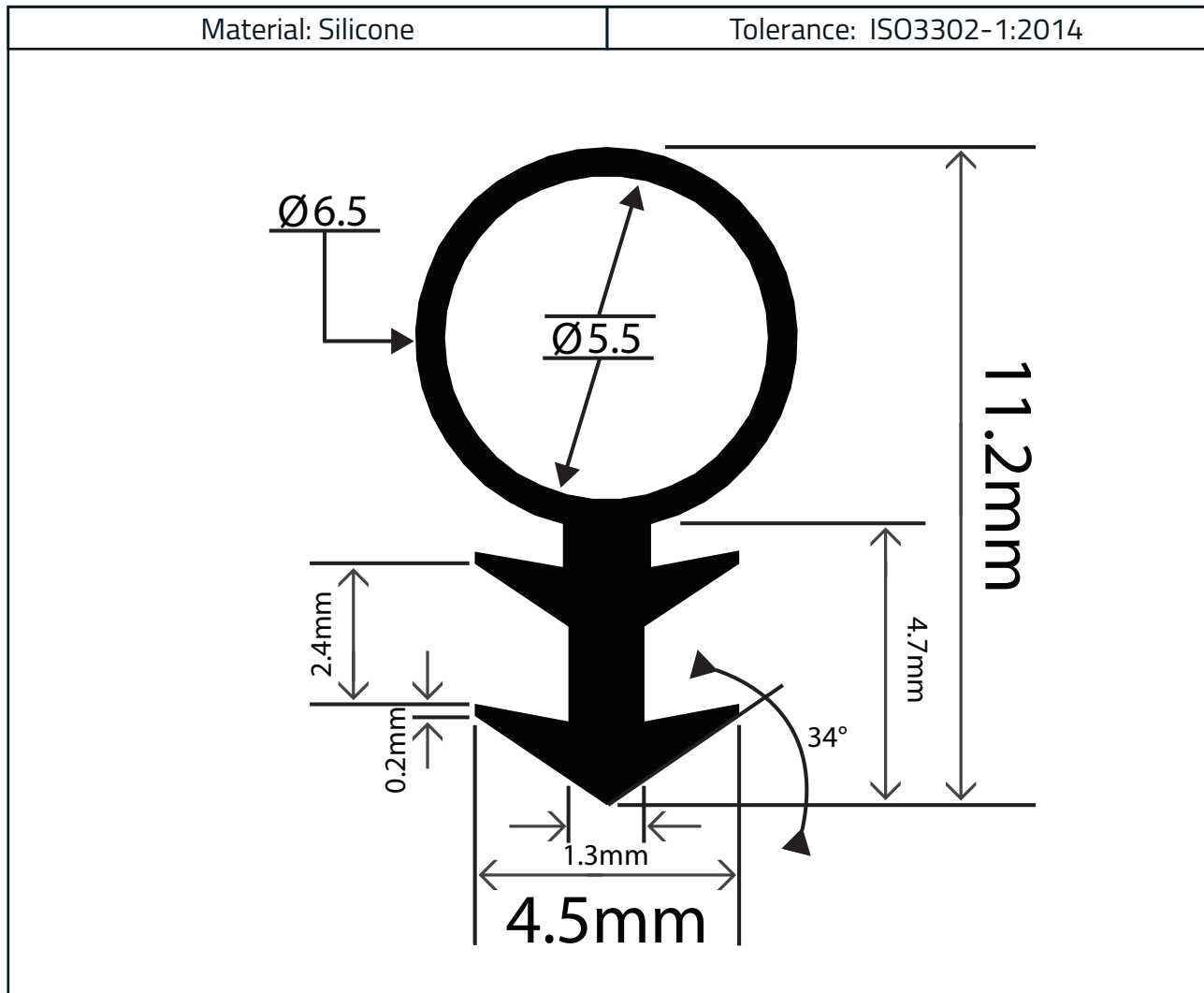

Measurements:

Height	Width
11.2mm	4.5mm

The information contained on this product information sheet is to be used as guidance. The advice is given in good faith and does not constitute any guarantee or recommendation for suitability. The Rubber Company cannot be held liable for any damage caused by incorrect installation. We hereby reserve the right to change the technical information herewith without notification or prior agreement.



Manufacturers · Designers · Distributors

Experts in
Rubber

Technical Data

Properties	Test Method	Values
Hardness (Shore A)	-	60°
Tensile Strength	DIN 53504 S1	11 N/mm ²
Elongation at Break	DIN 53504 S1	440%
Tear Resistance	ASTM D624 B	24 N/mm
Rebound Resilience	DIN 53512	57%
Compression Set (50% 23°C for 22 hours)	DIN ISO 815-B	31%



The information contained on this product information sheet is to be used as guidance. The advice is given in good faith and does not constitute any guarantee or recommendation for suitability. The Rubber Company cannot be held liable for any damage caused by incorrect installation. We hereby reserve the right to change the technical information herewith without notification or prior agreement.

E sales@therubbercompany.com • W www.therubbercompany.com • T +44 (0) 1794 513 184

The Rubber Company Limited - Registered in England and Wales
Company Number - 08350831 | VAT Number - GB 156 8355 80