

Hollow Silicone D Profile RCSHD11.2X7V

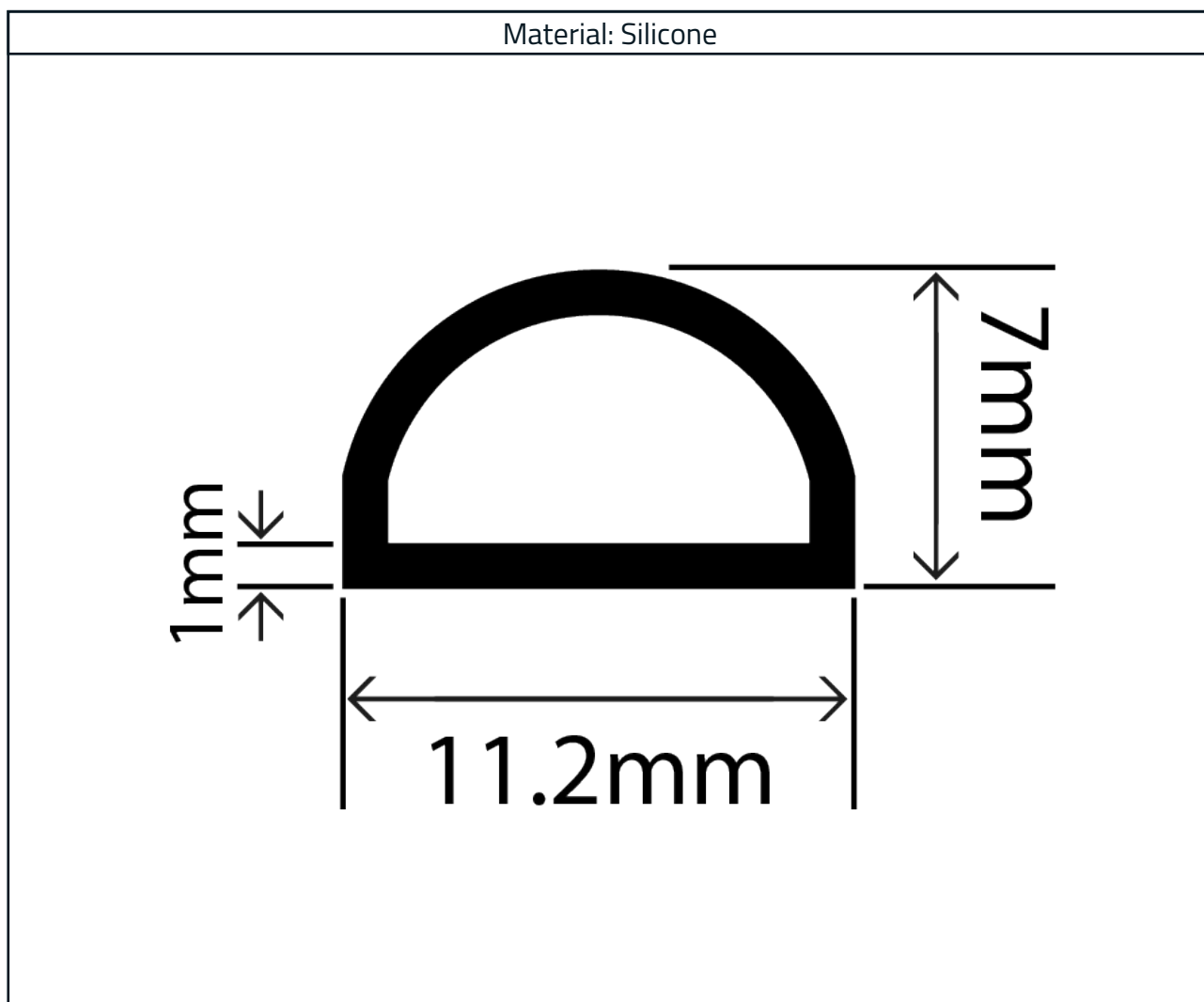

Measurements:

Height	Width
7mm	11.2mm

The information contained on this product information sheet is to be used as guidance. The advice is given in good faith and does not constitute any guarantee or recommendation for suitability. The Rubber Company cannot be held liable for any damage caused by incorrect installation. We hereby reserve the right to change the technical information herewith without notification or prior agreement.



Manufacturers · Designers · Distributors

Experts in
Rubber

Technical Data

Material Specification

Properties	Values
Polymer	Silicone
Hardness (Shore A)	52
Operating Temperature Range	-50°C to + 180°C (working) Up to 200°C (intermittent)
Density (Specific Gravity)	Approx. 1.15 g/cm ³
Tensile Strength	11 N/mm ²
Compression Set (20% Deflection at 70°C)	34%
Elongation at Break	520%



The information contained on this product information sheet is to be used as guidance. The advice is given in good faith and does not constitute any guarantee or recommendation for suitability. The Rubber Company cannot be held liable for any damage caused by incorrect installation. We hereby reserve the right to change the technical information herewith without notification or prior agreement.

E sales@therubbercompany.com • W www.therubbercompany.com • T +44 (0) 1794 513 184

The Rubber Company Limited - Registered in England and Wales
Company Number - 08350831 | VAT Number - GB 156 8355 80