

Silicone Inflatable Seal Profile 30mm x 17.5mm

Product Code: RC-IS6226

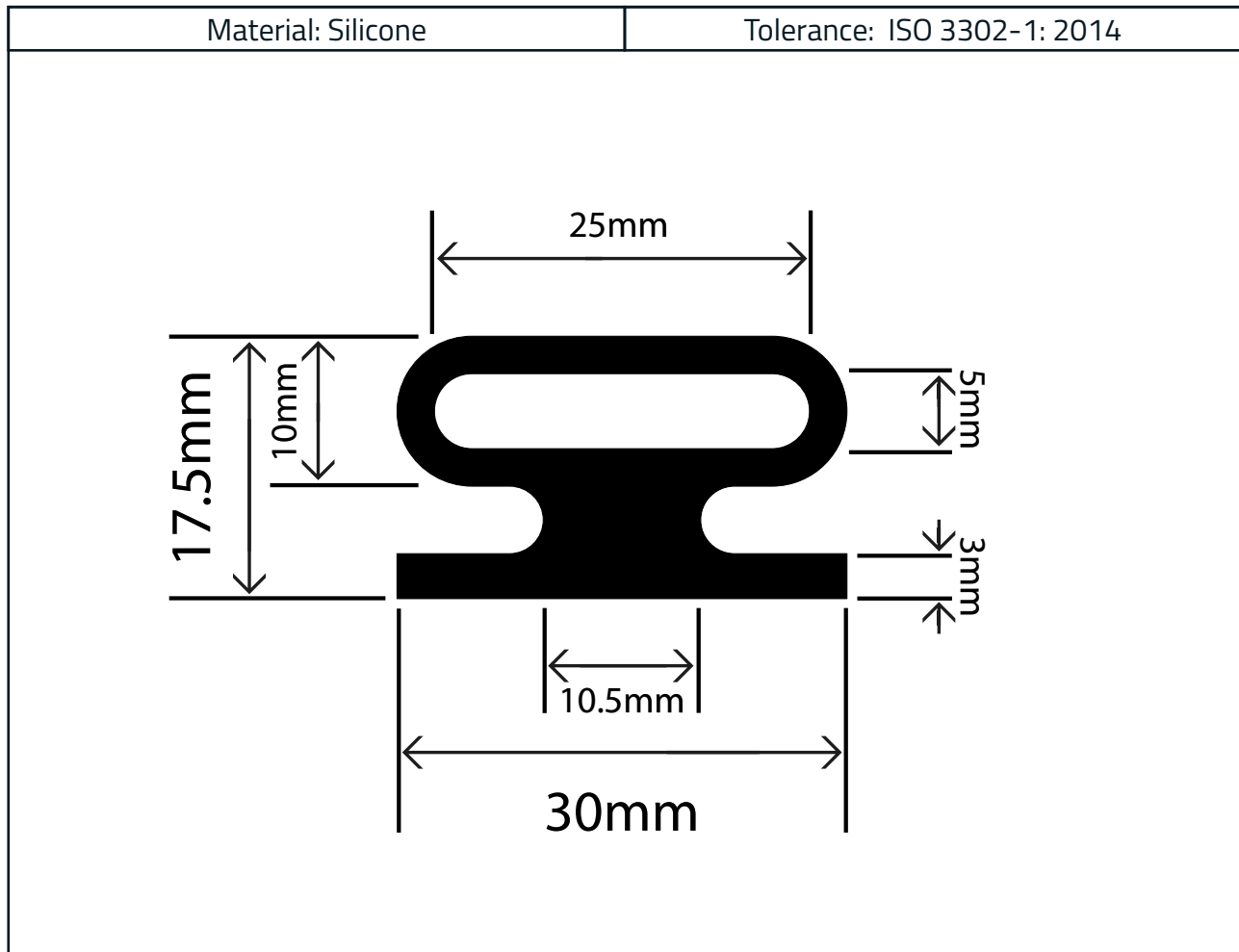

Measurements:

Height	Inflated Height	Width
17.5mm	29mm	30mm

Minimum Pressure	Recommended Pressure	Maximum Pressure
8 PSI	10 PSI	15 PSI

The information contained on this product information sheet is to be used as guidance. The advice is given in good faith and does not constitute any guarantee or recommendation for suitability. The Rubber Company cannot be held liable for any damage caused by incorrect installation. We hereby reserve the right to change the technical information herewith without notification or prior agreement.



Manufacturers · Designers · Distributors

Experts in
Rubber

Technical Data

Properties	Values
Hardness (Shore A)	60° +/- 5°
Density	1.16 kg/m ³
Tensile Strength	10 MPa
Elongation at Break	450%
Operating Temperature	-70°C to +200°C
Compression Set	35%

Properties	Values
ASTM Designation (ASTM D14/18)	VMQ
Tensile Strength	>1200
Hardness (Shore A)	60°
Tear Resistance	D
Abrasion Resistance	E
Compression Set	B
Cold Resilience	A
Heat Resilience	A
Radiation Resistance	C
Impermeability To Gases	D

Properties - Acid Resistance	Values
Mild Dilute	A
Strong Concentrate	D
Solvent Resistance	-
Aplihatic Hydrocarbons	E
Aromatic Hydrocarbons	E
Oxygenated (Keytones, etc)	E

Properties - Resistance	Values
Swelling In Lubricating Oil	E
Oil and Gasoline	D
Animal Oils	C
Water Absorption	A
Oxidation	A
Ozone	A
Sunlight Aging	A
Heat Aging	O
Low Temperature	O
Flame	D
Vegetable Oils	E
Chlorinated Hydrocarbons	E to D

A = Exceptional, B = Very Good, C = Good, D = Fair, E = Poor



The information contained on this product information sheet is to be used as guidance. The advice is given in good faith and does not constitute any guarantee or recommendation for suitability. The Rubber Company cannot be held liable for any damage caused by incorrect installation. We hereby reserve the right to change the technical information herewith without notification or prior agreement.

E sales@therubbercompany.com • W www.therubbercompany.com • T +44 (0) 1794 513 184

The Rubber Company Limited - Registered in England and Wales
Company Number - 08350831 | VAT Number - GB 156 8355 80